

YJ Planar Fast Recovery Diode Die Specification

400V 75A, Fast recovery diode die based on silicon planar process
Part No.: FRD75A400AS-290A

Main Products Characteristics

- Average forward current: $I_{F(AV)} = 75A$
- Maximum operating junction temperature: $T_j = 150\text{ }^\circ\text{C}$
- Planar Construction
- Top metal: Al

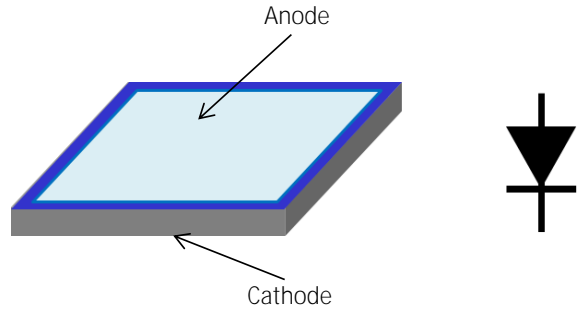

Maximum Ratings

Parameter	Symbol	Rating
Repetitive peak reverse voltage	V_{RRM}	400V
Average forward current	$I_{F(AV)}$	75A
Non-repetitive peak surge current ($t_p = 8.3\text{ ms}$, halfwave, 1 cycle)	I_{FSM}	700A
Storage temperature range	T_{stg}	-40 to +150 $^\circ\text{C}$
Maximum operating junction temperature	T_j	150 $^\circ\text{C}$

Static Electrical Characteristics ($T_a = 25^\circ\text{C}$)

Parameter	Symbol	Value	
		Spec	Typical
Reverse breakdown voltage $I_R = 50\mu\text{A}$	V_{BR}	420V	440V
Maximum forward voltage drop $I_F = 20A$, Pulse Test: $t_p = 380\text{ }\mu\text{s}$, $\delta \leq 2\%$	V_F	1.0V	0.95V
Reverse Recovery Time $I_F = 0.5A$, $I_R = 1A$, $I_{rr} = 0.25A$	T_{rr}	75ns	58ns
Maximum reverse current $V_R = V_{RRM}$ Pulse Test: $t_p = 10\text{ ms}$, $\delta \leq 2\%$	I_R	2 μA	0.05 μA

Device Schematics and Outline Drawing

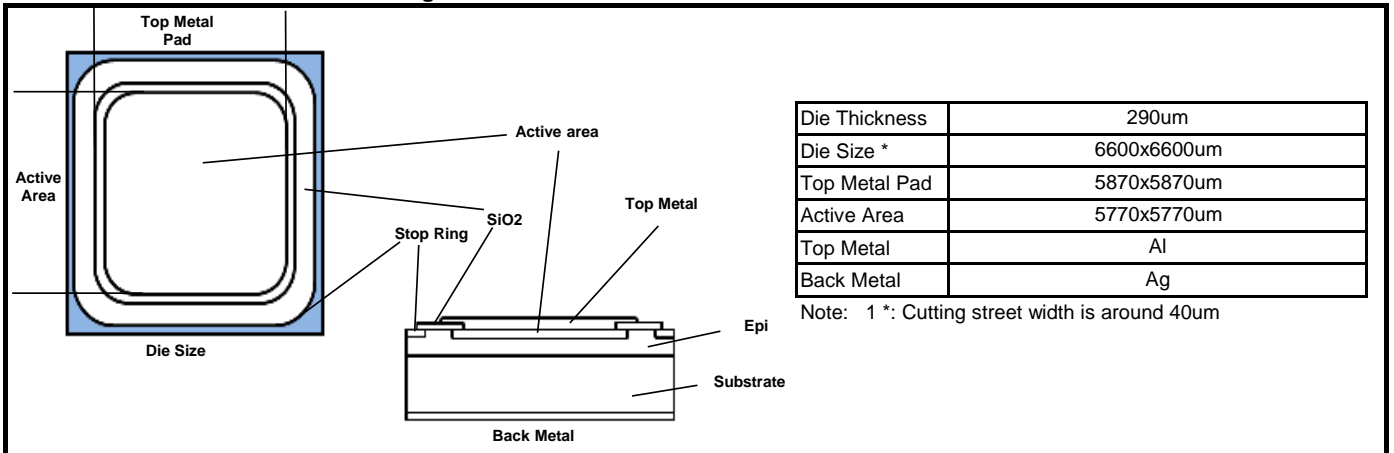

Important Notice

<p>Specification apply to die only. Actual performance may degrade when assembled.</p> <p>Yangjie Electronics does not guarantee device performance after assembly. All operating parameters must be validated for each customer application by customer's technical experts.</p> <p>Data sheet information is subjected to change without notice.</p>	<p>Recommended Storage Environment:</p> <p>Store in original container, in dessicated nitrogen, with no contamination.</p> <p>Shelf life for parts stored in above condition is 2 years.</p> <p>If the storage is done in normal atmosphere shelf life is reduced to 6 months.</p>
---	--